



HOUSE of PURITY



Innovations for Better Living

Marketed by:

**KENT RO SYSTEMS LTD.**

E-6, 7 & 8, Sector-59, Noida, U.P.-201 309, India.

E-mail: [sales@kent.co.in](mailto:sales@kent.co.in) | Website: [www.kent.co.in](http://www.kent.co.in)

Manufactured by:

**KENT RO SYSTEMS LTD.**

1) Khasra No.93, Village-Bantakhedi, Tehsil-Roorkee, District-Haridwar, Uttarakhand-247 668, India.

2) A-6, Sector-87, Noida-201 305, U.P., India.

For customer complaints, contact Customer Care Officer at:

E-6, 7 & 8, Sector-59, Noida, U.P.-201 309, India. Call: 92-789-12345

E-mail: [service@kent.co.in](mailto:service@kent.co.in) or Visit us at [www.kent.co.in](http://www.kent.co.in)

KENT  
*Alps+UV*  
Air Purifier

HEPA  
Technology

Removes  
Particulates  
From Air

High CADR &  
High Capacity

KENT  
*HEPA*  
Air Purifiers

HOUSE of PURITY

Instruction Manual



Real Time PM 2.5 Monitoring  
of Purified Air Quality

Kent Air Purifier Banaye  
**Sabse  
Shudh Hawa**



HEPA Room Air Purifier  
with UV LED, Purity Indicator  
High CADR & Capacity

# Welcome to KENT

Dear Customer,

At the outset, allow us to thank you for your trust in **KENT Alps+ UV Air Purifier**.

At KENT, we take pride in our reputation for product quality and industry proven performance. We are certain that your decision to own **KENT Alps+ UV Air**

**Purifier** will go a long way towards keeping you and your family in good health.

We are confident that you will be more than satisfied with its performance and that it will serve your need for safer and purer living without any compromise.

This guide would help you in getting the best out of your **KENT Alps+ UV Air Purifier**. Please go through the booklet to familiarize yourself with operation and maintenance.

You can look forward to years of trouble-free service. In case you require any further information, please contact your nearest KENT dealer or branch.

Happy Living

KENT RO SYSTEMS LTD.

## Table of Contents

1. Introduction	1
2. Salient Features of KENT Alps+ UV Air Purifier	1
3. Know Your Product	1
4. Items in the Box	2
5. HEPA Technology	2
6. Filtration Process	2
7. Setting up the KENT Alps+ UV Air Purifier	2
8. Using KENT Alps+ UV Air Purifier	4
9. PM 2.5 Display	5
10. Air Quality Indicator-Gas	5
11. Cleaning and Maintenance	6
12. Precautions	8
13. Important Safety Instructions	9
14. Troubleshooting	9
15. Technical Specifications	10
16. Spare Part List	10

## Introduction

At KENT, we believe clean and healthy living is a right of every individual. This ethos made us embark on a journey to develop solutions for purifying water, vegetable and air. Using innovative technology, customer first approach and pan India service network, we have been able to create a name, synonym with well-being and health.

With every passing day, the air quality is worsening. The air inside our homes is more polluted than the air outside. The high concentration of indoor pollutants have an adverse effects on our health.

Bacteria, dust, pollen, odors, hazardous gases (e.g., formaldehyde, benzene, etc.), soot, second-hand smoke, etc. the list is endless. These pollutants have a high shelf life up to 240 hours in some cases and these are known to cause complications like asthma, flu and other respiratory diseases.

On a day-to-day basis, we spend around 90% of time indoors (in office or at home), and the quality of indoor air is critical to our health.

To safeguard you and your loved ones against this profound threat, and to provide clean and pure air, we present KENT Alps+ UV Air Purifier, with 4 stage filtration technology, UV LED light and with real time monitoring of pollutions and PM 2.5.

## Salient Features of KENT Alps+ UV Air Purifier

1. Air purifier with UV LED Light which kills bacteria & Viruses or any other germs present within the air before it throws out clean and fresh air.
2. Real time monitoring and display of PM 2.5 (Particulate Matter) for indoor air.
3. HEPA (High Efficiency Particulate Arrestor) dust collection technology.
4. High CADR (Clean Air Delivery Rate) of 400 m<sup>3</sup>/hr.
5. Activated carbon filter removes odour and formaldehyde etc.
6. Intelligent Air Quality monitoring.
7. Filter change indicator.
8. Low noise/silent operations.
9. User-friendly functional design, safe and convenient for use.
10. Suitable for a room size upto 430 sq.ft.
11. Fresh & pure air free from Bacteria & Virus.

## Know Your Product

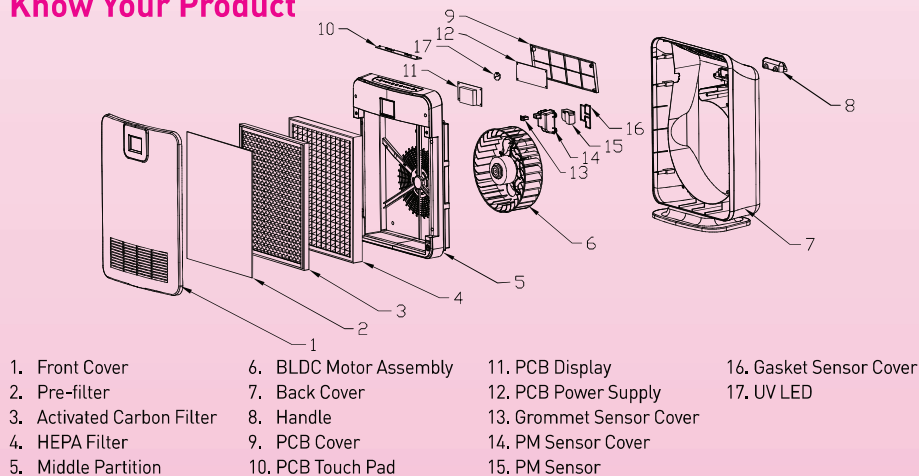

## Items in the Box

1. KENT Alps+ UV Air Purifier : 1 No.
2. Warranty Card : 1 No.

## HEPA Technology

HEPA (High Efficiency Particulate Arrestor) is a type of a mechanical air filter, which remove 99.97% of particles of size less than 0.3 microns (micron is one millionth of a metre) in diameter from the air passed through it.

HEPA uses three different mechanisms (Impact, Interception and Diffusion) to catch and trap carcinogen particles, which are larger than 0.3 micron size and can be commonly found at homes such as dust mites, mold spores, pollen, pet dander and tobacco smoke.

These carcinogens particles have high shelf life and are highly injurious to health and cause variety of health hazards including allergy, asthma and lung cancer and these cannot be removed by normal filters available in the market.

## Filtration Process

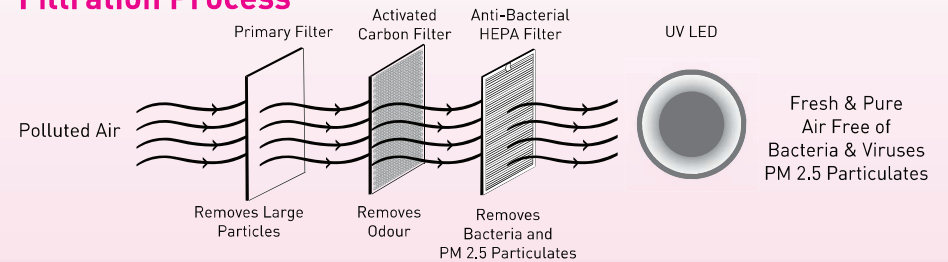

## Setting Up the KENT Alps+ UV Air Purifier

Your KENT Alps+ UV Air Purifier is equipped with three filter for effective and efficient air filtration. Acting as a line of defense, each filter performs a customised role.

### Filter 1: Primary Filter

The filter acts as a first line of defense, removes large and visible pollutants such as:

1. Large particle dust
2. Human and pet hair
3. Debris
4. Cobwebs

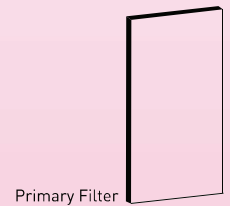

### Filter 2: Activated Carbon Filter

The activated carbon filter removes any smell/odour including:

1. Cigarette smoke (smell)
2. Foul odour
3. Pet smell
4. Formaldehyde
5. Benzene
6. TVOC

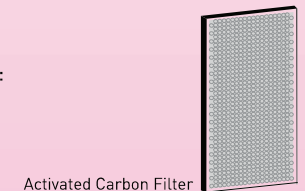

### Filter 3: Anti-Bacterial HEPA Filter

The Anti-Bacterial HEPA filter catches and traps various carcinogenic particles and pollutants such as:

1. Bacteria
2. Pollen
3. Allergens
4. Mould
5. Dust
6. Cigarette smoke particles

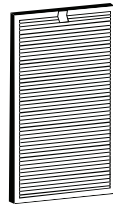

Anti-Bacterial HEPA Filter

### Installing Filters

This appliance comes with filters covered in plastic covering to prevent any wear and tear. This protective covering must be removed before using the appliance.

1. Unplug the appliance.
2. Put fingers in the groove at the upper part of the front panel.

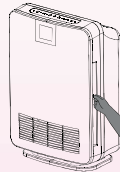

3. Gently pull and remove the front panel.

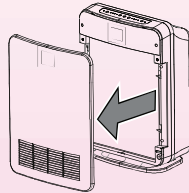

4. Remove filters from the product. Gently remove the protective plastic packaging.

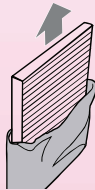

5. Place HEPA filter.  
Please ensure the filters are installed in the correct order only.

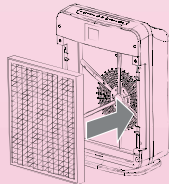

6. Place Activated Carbon Filter followed by Primary Filter (maintaining the order) and in correct position only.

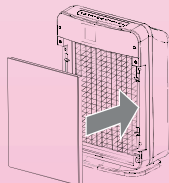

**Note:** Please ensure that the filters are installed in correct position only failing to do so would hamper the purification process..

7. Before installing the front panel, ensure that all the filters are correctly placed.
8. To put the front cover in the air purifier, insert the snaps on top of the front cover into slots, and push till you hear a 'click'.

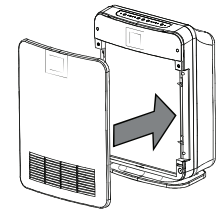

### Using KENT Alps+ UV Air Purifier

1. Remove any stickers that can prevent unit operation.
2. Ensure that filters are installed in the correct format only.
3. Check the unit for damages, do not use it in case of any damages.
4. Before switching the unit on, make sure that your home mains voltage corresponds to the unit operating voltage.
5. Once connected to the main power supply, the appliance will give a single 'BEEP' indicating that it is ready for use.

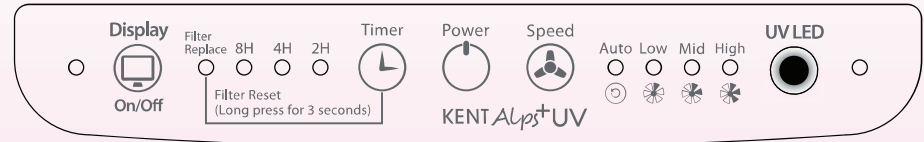

6. To start the KENT Alps+ UV Air Purifier, press the 'POWER' button. The appliance will give a 'beep' to indicate that it is on. The appliance would start with Auto-Mode and with UV LED turned on.
7. To turn off the appliance, press the 'POWER' button.

### Speed

KENT Alps+ UV Air Purifier comes with four different speed settings. These different speed settings – Auto, Low, Medium & High allow you to select a particular speed to suit your needs.

To vary speed, press speed button on the control panel.

1. For Low speed - press speed button once.
2. For Medium speed - press speed button twice.
3. For High speed - press speed button thrice.

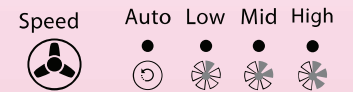

### Timer

KENT Alps+ UV Air Purifier comes with three different timer settings.

These different settings – 2 hours, 4 hours & 8 hours, allow you to select a usage as per your need.

To set timer, press timer button on control panel.

1. To Set timer for 2 hour - press button once.
2. To Set timer for 4 hours - press button twice.
3. To Set timer for 8 hours - press button thrice.

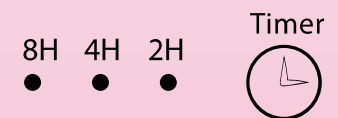

When the set time is up, the purifier will turn off.

## Filter Reset

When 'REPLACE FILTER' LED glows, it indicates that the filter's life is up and it needs to be replaced.

The 'REPLACE FILTER' LED will glow after 2000 hours of usage in normal course or when the filters are choked.

After replacing the filters, press and hold 'TIMER' button for 3 seconds to reset the 'REPLACE FILTER' indicator for filter replacement.

**Note:** The life of the filter is indicated as 2000 hours and would depend on the quality of air being filtered.

**Warning:** It is important to reset the machine, failing to do so the photosensitive sensor might damage.

## Display On/Off

PM 2.5 Display can be turned ON or OFF by pressing the display ON/OFF switch. In case display is switched OFF then it will remain in switch OFF mode till it is turned ON by pressing the display switch.

### Display



On/Off

## UV LED

UV- C light, which is also found in the sun light spectrum, is very effective at disinfection. It can kill all germs, viruses and bacteria.

KENT Alps+ uses UV LEDs which produce this light effectively and produce environment in which bacteria, germs and viruses can not survive. It eliminates all of them as the air passes through it. The technology is aimed at providing environment which minimizes diseases due to viruses also.



The UV LED can be switched on, with the help of UV button, when Power is ON. UV ON is indicated with light indication.

In case of any malfunction the UV indicator light will start blinking and beep sound will be heard intermittently.

## PM 2.5 Display

The digital screen on the Alps+ UV Air Purifier displays PM 2.5 density in  $\mu\text{g}/\text{m}^3$  inside the room. Using laser scattering technique, it detects PM 2.5 levels (on a real time basis) with a high accuracy levels and displays them on the screen, thus enabling you to know the change in the pollution level before and after the use of Alps+ UV Air Purifier.

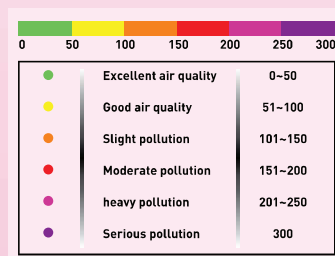

Pollution level of Particulate Matter PM 2.5 are indicated using different colour.

## Air Quality Indicator-Gas

KENT Alps+ UV Air Purifier comes with an in-built sensor and a display to indicate

the air quality in the room. The air quality is indicated by a glowing LED which also displays speed settings.

Once the appliance is started, the air quality requires around 3 minutes to initiate and displays pink colour only. After 3 minutes, the sensor displays colour in accordance to the air quality in the room. The colour parameters are as described below.

Blue: Excellent

Pink: Good

Red: Poor

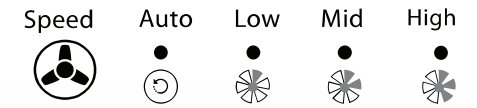

**Note:** In the first 3 minutes after the machine is turned on, the sensor is in preheat stage, so the air quality indicating lights would display only pink colour. Any air quality information is only for reference before it becomes stable.

## Cleaning and Maintenance

To keep your KENT Alps+ UV Air Purifier spotless, please ensure a periodic cleaning of your purifier.

1. Switch off and unplug the appliance from mains power supply.
2. Regular clean the appliance to prevent accumulation of dust. Wipe the appliance with a soft cloth to remove any dust or dirt.
3. Clean the display using micro fiber cloth do not use water for cleaning.
4. Keep the vents for sensor clean & do not allow dust to accumulate.
5. In case of few stubborn marks, wipe with a soft cloth dipped in household detergent.
6. Do not use the machine till it is completely dry.
7. Do not clean the appliance by immersing it in water or under tap water. It might lead to serve defects in the appliance.
8. Do not use cleaning agents, such as bleach or alcohol, that can cause corrosion or flammable.
9. The air quality sensor needs to be cleaned once every 2 months to ensure excellent performance from the appliance.
10. If the purifier is used in a dusty environment, please clean it regularly.

## Cleaning Filters and Air Quality Sensor

To ensure optimised air quality and longer life, it is advised to clean air quality sensor, PM 2.5 sensor vents and outer filter on periodic basis.

## Cleaning Air Quality Sensor Vents

Clean the air quality sensor vents after every 2 months of usage. Gently brush (with a soft brush) the area around air quality sensor as shown in the figure.

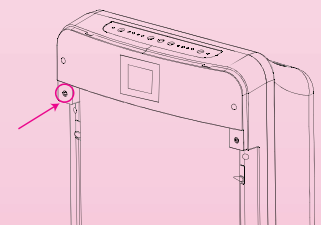



### Cleaning PM 2.5 Sensor Vents

Clean the area around the PM 2.5 sensor vents regularly with a soft brush or a micro fibre cloth and do not allow dust to accumulate.

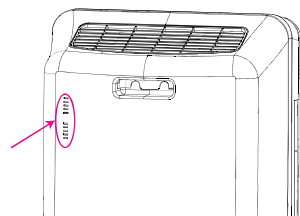

### Cleaning of Filters

#### 1. Primary Filter

Clean the primary filter after every 2 weeks of usage. Clean primary filter either with a vacuum cleaner or with a soft brush.

#### 2. Anti-Bacterial HEPA and Activated Carbon Filter

Clean Anti-Bacterial HEPA and Activated Carbon Filter once every 2 weeks of usage.

- To clean the filter, put it facing downwards on a newspaper or any other protective surface.
- Clean the filters using a soft brush or with vacuum cleaner (using brush nozzle or crevice nozzle) to remove the dust on the surface.
- Do not exert any excessive force on the HEPA or Activated Carbon Filter. Doing so might lead to its deformation.

**Note:** The filters should not be washed under any circumstances.

### Replacement of Filters

When it's time to replace the filter, it would be automatically indicated by the appliance through flashing of the 'Filter Replacement Indicator'. When the 'Filter Replacement' LED starts flashing, replace the filter and reset the filter.

Put your fingers in the groove at the upper part of the front panel, and gently pull to remove front panel.

**Note:** Do not use excessive force. The front panel can be easily removed.

### Removing Activated Carbon Filter and Primary Filter

Remove Activated Carbon Filter by holding its handle and pulling it out gently.

**Note:** Since the Primary Filter is fastened to the Activated Carbon Filter, first remove the Activated Carbon Filter followed by the Primary Filter.

### Remove HEPA Filter

Remove HEPA filter gently by holding its handle and pulling it out. Replace the filters by removing the new filter from its protective covering and install in the reverse order.

After replacing all the filters, plug the appliance to the main socket and restart it.

**Note:** After replacing the filters, press 'TIMER' button to reset the filter. Hold till you hear three 'Beeps' indicating that the filters have been reset.

**Warning:** It is important that proper instructions are followed when cleaning or replacing the filter. Not adhering to proper procedures may impair the performance of the appliance.

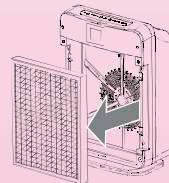
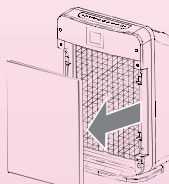
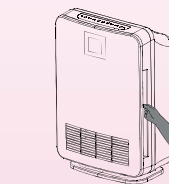

### Precautions

- Do not disassemble, repair or alter the machine on your own. It may cause appliance failure or breakdown.
- The input voltage must not exceed the rating; it might damage the appliance.
- Unplug before replacing the filter/cleaning/moving the appliance.
- Do not use the appliance with damaged power cord or plug.
- If power cord is damaged, replace it with a genuine KENT spare.
- Do not install the machine in a high humidity area e.g., bathroom. The vapor may result in electric shock or breakdown.
- Do not use the appliance in places with combatable liquids or heavy oil stain (e.g., machine oil). This may result in breakdown, electric shock or combustion.
- Do not use water or any cleaning agent for cleaning the display screen. Use only micro-fibre cloth.
- Vents for sensor should remain free of dust and should not be covered.
- Do not install the machine near any heat source, e.g., heater.
- Do not use the appliance for soot ejection or for ventilation in kitchen. This would result in reduced service life of the filter and even the appliance might get damaged.
- Do not stick fingers or any other objects into the air outlet.
- When using pesticide, turn off the appliance to prevent any chemical from being sucked in. The chemicals may accumulate in the machine and generate hazardous pungent substance under certain circumstances.
- When the machine is used together with humidifier, prevent excess water vapor from entering into the machine, because water vapor could lead to electric shock and damage the machine.
- Do not block the air intake and outlet, which may otherwise reduce the machine's cleaning capacity (the indoor air may not be cleaned thoroughly) and result in machine breakdown.
- Do not place the appliance near any water source such as fish tank or vase. If water enters into the machine, it may cause electric shock or malfunction.
- If the machine is not be used for longer time, unplug it.
- Do not sit, stand or shake the appliance.
- Do not use the machine when it is in recumbent or in a inclined position.
- Do not attempt to use the machine to remove some toxic substance, e.g., carbon monoxide.
- Do not use the machine at heavily smoky or dusty place, e.g., kitchen or where flammable gas, caustic gas or metal dust may have access, which may otherwise cause fire or failure.
- Always use KENT Genuine Spares for effective purification.

## Important Safety Instructions

When using an electrical appliance, basic precaution should always be followed, including the following:

1. Unplug, when not in use and before servicing.
2. To reduce the risk of electric shock, do not use it near or on wet surfaces.
3. Use the appliance only as described in the manual.
4. Do not use the appliance if cord or plug is damaged or worn out. Replace the damaged cord or plug immediately.
5. Do not try to service the appliance on your own. Send it to an authorised service centre only.
6. Keep the cord away from heated surfaces.
7. Do not unplug the appliance by pulling the cord. Always unplug by pulling the plug and not the cord.
8. To avoid electric shocks, do not use the appliance with wet hands.
9. Keep hair, loose clothing, fingers and all parts of body away from the moving parts.
10. Turn all controls off before unplugging.
11. Never use the appliance without filter in place.
12. This appliance is suitable for indoor use only.
13. Keep away from the children.
14. The appliance is not designed to be used by people who are physically or mentally disabled or mentally handicapped or lack of relevant experience and knowledge, unless a person responsible for their safety uses the product for supervision or guidance.
15. Do not put the product directly under air conditioning, to prevent condensation of water droplets into the product.

## Troubleshooting

PROBLEM	POSSIBLE CAUSE	POSSIBLE SOLUTIONS
The appliance does not switch on.	<ul style="list-style-type: none"> <li>• Power cord not firmly plugged into socket.</li> <li>• No power in the main supply.</li> <li>• Front panel not installed properly</li> </ul>	<ul style="list-style-type: none"> <li>• Plug the unit firmly</li> <li>• Check the fuse or cut out switch. Replace fuse or reset the switch.</li> <li>• Install front panel properly.</li> <li>• Call KENT authorised service center.</li> </ul>
Air not coming out	<ul style="list-style-type: none"> <li>• Air intake or outlet is blocked.</li> <li>• Protective plastic packaging has not been removed.</li> <li>• Motor doesn't work.</li> </ul>	<ul style="list-style-type: none"> <li>• Change the position or remove the blockage.</li> <li>• Remove plastic packaging.</li> <li>• Call KENT authorised service center.</li> </ul>
There is no effective purification	<ul style="list-style-type: none"> <li>• The machine is installed at a poorly ventilated place or there is an obstacle nearby.</li> <li>• Anti-Bacterial HEPA/Activated Carbon/Primary Filters are overused and require replacement.</li> </ul>	<ul style="list-style-type: none"> <li>• Remove the obstacle.</li> <li>• Replace Anti-Bacterial HEPA/or Activated Carbon/ Primary Filters.</li> </ul>
Foul odours coming from the Air Purifier	<ul style="list-style-type: none"> <li>• The foul odours may be due to excessive smoking in a shorter interval of time.</li> <li>• Anti-Bacterial HEPA/Activated Carbon/Primary Filters are overused and require replacement.</li> </ul>	<ul style="list-style-type: none"> <li>• The odours will disappear after a while.</li> <li>• Change Anti-Bacterial HEPA /Activated Carbon/ Primary Filters are overused and require replacement.</li> </ul>
Display not Turning ON	<ul style="list-style-type: none"> <li>• Display switch in 'OFF' mode.</li> </ul>	<ul style="list-style-type: none"> <li>• Press Display Switch to Switch 'ON'.</li> </ul>

## Technical Specifications

Product	KENT ALPS+ UV AIR PURIFIER
Product Code	115008
Product Generic Name	Air Purifier
Product Colour	White
Mounting	Pedestal
Net Weight	8 kg
Input Power Supply	Single Phase 220-240 V, AC 50-60 Hz.☐
Product Dimensions (mm)	410 (L) X 245 (W) X 580 (H)
Effective Room Area	Up to 430 sq. ft.
Noise	<= 54 dB (A)
CADR (Clean Air Delivery Rate)	400 m <sup>3</sup> /h
Power Consumption	70 W
PM 2.5 (Sensing Range)	0-1000 µg/m <sup>3</sup>
UV LED Wattage	1.3 W

## Spare Part List

Replacement of spare parts are as:

1. Primary Filter
2. Anti-Bacterial HEPA Filter
3. Activated Carbon Filter

**Note:** The filters are consumables. Their replacement time depends upon the quality of air being purified. They are not covered under warranty.